









World Taekwondo Guidelines on World Taekwondo Logo, Manufacturer Identification (MI), Homologation Mark (CE) and Technical Requirements for WT-recognized Products

as of March 1, 2022

Contents

| | |
|---|-----------------------------------|
|  | Kyorugi Competition Uniform #1~#3 |
|  | Poomsae Competition Uniform #1~#3 |
|  | Dobok Uniform #1 |
|  | Protector - PSS / Non-PSS |
|  | Personal Equipment |
|  | Taekwondo Mat (Puzzle) |
|  | Application of WT Logo guidelines |

[Important Notice]

The use of products with the **WTF logo** is strongly **prohibited**.



KYORUGI COMPETITION UNIFORM #1

*MI – Manufacturer's Identification



Front

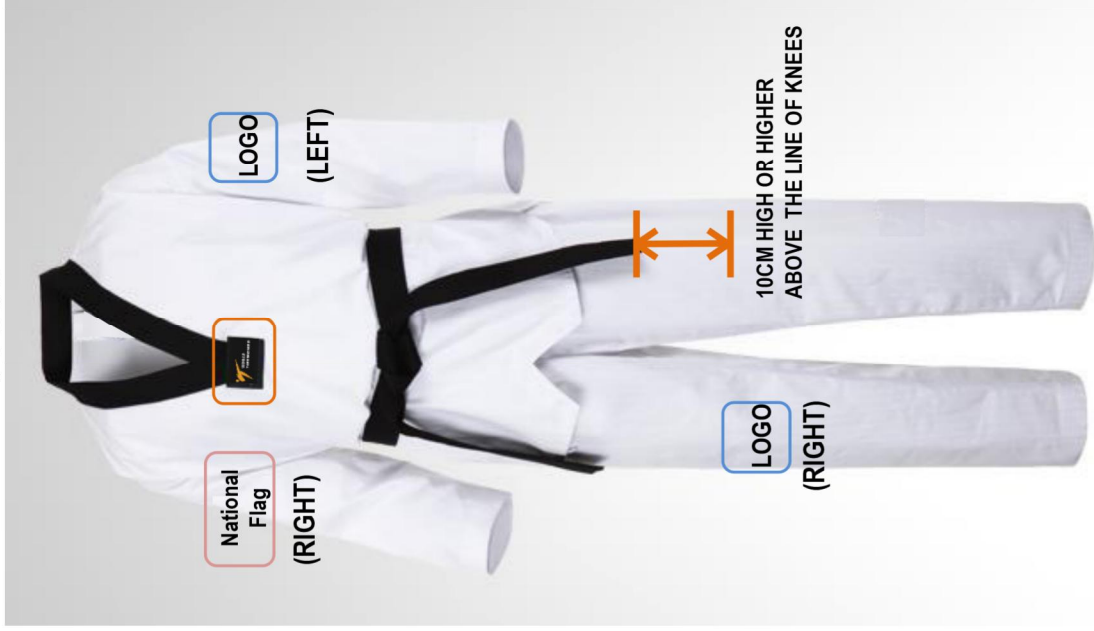

Back



| * World Taekwondo LOGO (One per item) | |
|---------------------------------------|---|
| TOP | In front of the upper garment where the black neck bands are met/by embroidery (on black background color of the patch) |
| TROUSERS | None * Belt is considered to belong to Kyorugi uniform in 'World Taekwondo' recognition products. |



28 cm²
(7cm x 4cm)

| * LOCATIONS FOR OTHER PURPOSES | | |
|--------------------------------|--|-------------|
| National Flag | 3 to 3.5cm below from the shoulder line of the right arm | 10cm x 7cm |
| NOC Code | The NOC code must be printed in black, using bold Verdana font, and located 5cm high or higher from the lower edge of the back of the Kyorugi top. | 30cm x 12cm |

KYORUGI UNIFORM

MANUFACTURER'S IDENTIFICATION (ONE PER ITEM)

HOMOLOGATION MARK (CE)

| CLOTHING | LOCATION | SIZE | LOCATION | SIZE |
|----------|--|--------------------------|----------|------|
| TOP | 3 to 3.5cm below the shoulder line of the left arm | within 30cm ² | None | None |
| TROUSERS | Above the knee, center of the right leg | within 30cm ² | None | None |
| BELT | At one end of the belt | within 6cm ² | None | None |

* WT Competition Uniform Manufacturer

- Considering the design and material, the top and trousers should be sold separately instead of a set
- There is no change required to belts.

| Material | FABRIC |
|------------|---|
| Properties | Quick dry, breathable and elastic fabric should be used for both top and trousers of the competition uniform. ※ <i>Material for the competition uniform must be different from the one that has been used for dobok.</i> |
| Color | Top and trousers: Off-white / V-neck collar: Black |
| Remark | In case another material is used for ventilation area, it must be the same color as overall fabric material. |

Size Specification (Top – Regular fit)

For your reference, 170 size is provided and this could be adjusted within $\pm 0.5 \sim 1.0$ cm. Size variation should be within $\pm 1.5 \sim 3.0$ cm.
(ex. For 160, Length within 87.0~89.5 cm / For 180, Neck within 23.5~25.0 cm)

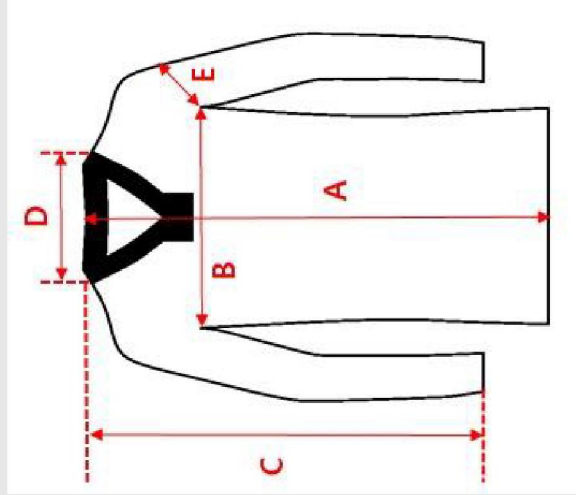

| Size 170 | (cm) |
|--------------------|------|
| Length (A) | 90 |
| Chest width (B) | 51 |
| Sleeve length (C) | 75 |
| Neck (D) | 22 |
| Arm-hole width (E) | 20 |

Length of front and back should be the same.

In order to enable free movement, it must have slits on both sides.
The length from the bottom of top should be **20.0~25.0 cm**

The top has to cover completely the buttocks. However, the bottom of top should be more than **15cm** above the knee cap.

The width of V-neck collar is **4 cm** and the neck depth should be **18.0~20.0 cm**.

The sleeves must cover up the full arms. The distance between the end of sleeves and the carpal bone must be less than **3 cm**.

Forearm guards shall be worn inside the top.

KYORUGI COMPETITION UNIFORM #3

*MI – Manufacturer's Identification



Size Specification (Trousers – Slim fit)

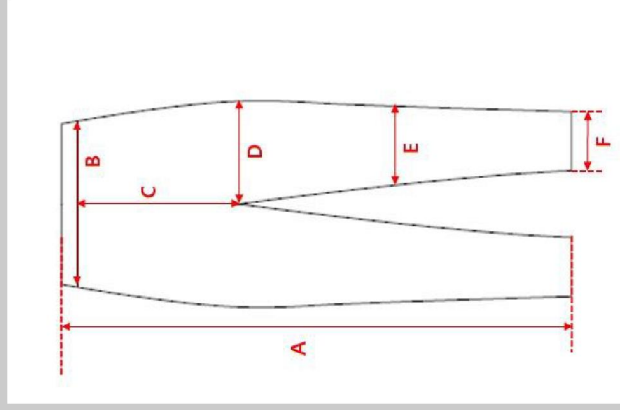

| Size 170 | (cm) |
|------------|------|
| Length (A) | 94 |
| Waist (B) | 35 |
| Inseam (C) | 29 |
| Thigh (D) | 25 |
| Knee (E) | 19 |
| Ankle (F) | 15 |

The trousers will maintain a traditional shape but with a slimmer thigh and knee.

The legs of trousers must not cover the ankle bone.

Shin guards and groin guards shall be worn inside the trousers.

**One additional identification, strictly limited to Product Technology Identification, shall be permitted per clothing item and shall not exceed 10 cm².*

**No identification of the Manufacturer may appear on the front and back collar.*





Wrong samples made differently from the specifications of the Kyorugi Competition Uniform

| | | | | | | | | | |
|--------|--|--|--|--|--------|---|--------------------------------|-------------------------------|--|
| Sample | | | | | Remark | Small WT logo patch Too wide V-neck collar | Printed WT logo on the uniform | Using incorrect WT logo color | WT logo should be contacted with V-neck collar |
|--------|--|--|--|--|--------|---|--------------------------------|-------------------------------|--|

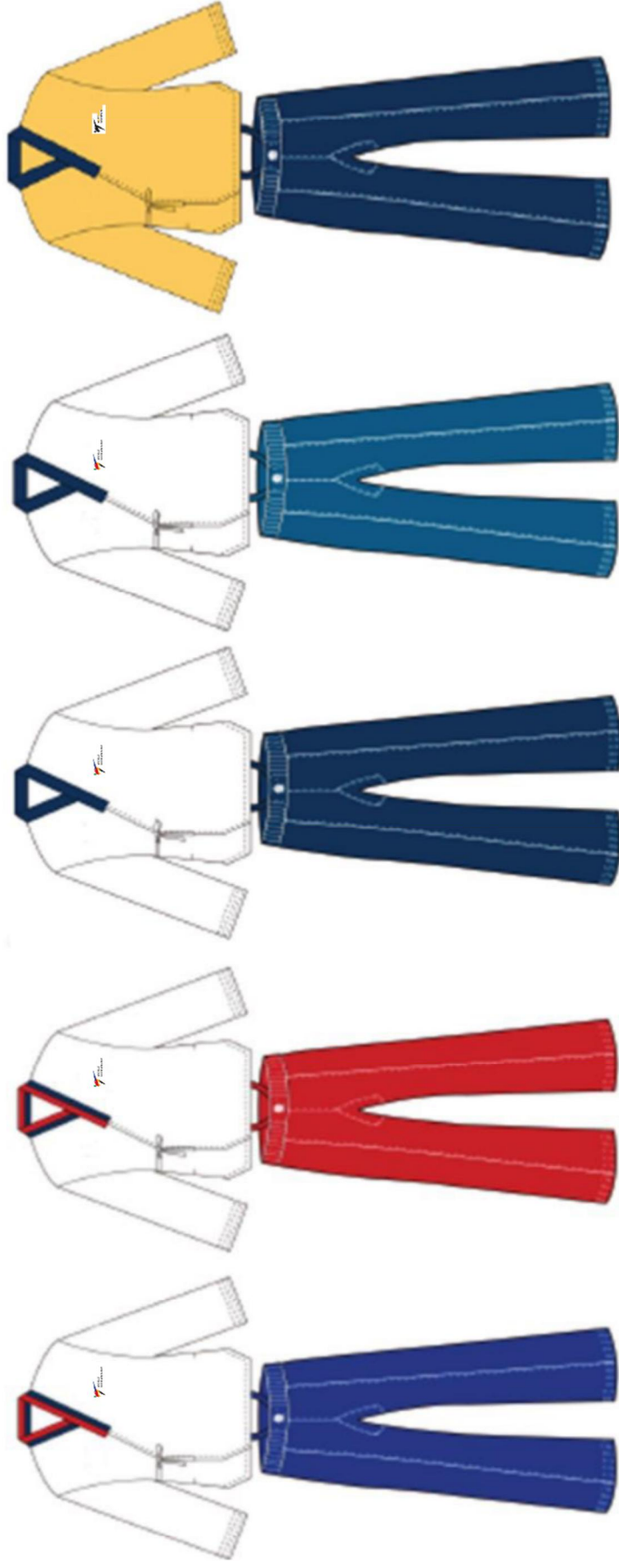
POOMSAE COMPETITION UNIFORM #2

*MI – Manufacturer's Identification



| POOMSAE UNIFORM | Cadet Male (12-14) | Cadet Female (12-14) | Junior/Senior Male (15-50) | Junior/Senior Female (15-50) | Master M/F (51 and up) |
|------------------------|--|---|---|---|--|
| Belt | Black and Red (Poom Belt) | Black and Red (Foom Belt) | Black (Dan Belt) | Black (Dan Belt) | Black (Dan Belt) |
| TOP (CMYK) | White color (white 100) | White color (white 100) | White color (white 100) | White color (white 100) | Gold Color (C:0 / M:25 / Y:70 / K:0) |
| TROUSERS (CMYK) | Blue Color (C:90 / M:65 / Y:25 / K:30) | Red Color (C:5 / M:90 / Y:100 / K:0) | T-Black Color (C:100 / M:65 / Y:25 / K:60) | Light Blue Color (C:100 / M:50 / Y:20 / K:10) | T-Black Color (C:100 / M:65 / Y:25 / K:60) |
| WT Logo |  |  |  |  |  (Black solid color) |
| Remark | One additional identification, strictly limited to Product Technology Identification, shall be permitted per clothing item and shall not exceed 10 cm ² . No identification of the Manufacturer may appear on the front and back collar. | | | | |

POOMSAE COMPETITION UNIFORM #3

*MI – Manufacturer's Identification

* LOCATIONS for NOC code

Back of the Poomsae uniform



- Black Color Only
- Centered 12cm from the Top Line
- Size of 30cm width x 12cm height
- Font – “Verdana Bold”

DOBOK UNIFORM #1

*MI – Manufacturer's Identification



Front

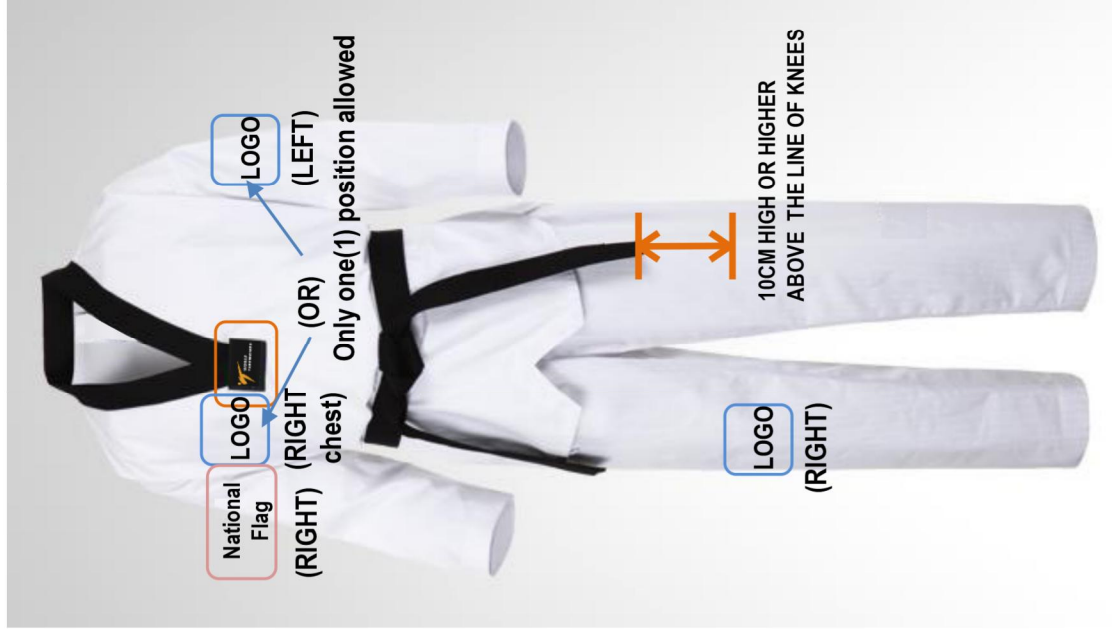

Back



| * World Taekwondo LOGO (One per item) | |
|---------------------------------------|---|
| TOP | <p>In front of the upper garment where the black neck bands are met/by embroidery (on black background color of the patch)</p> <ul style="list-style-type: none"> ➤ Color of the V-neck Collar <ul style="list-style-type: none"> - Senior / Junior : Black (Dan) - Cadet : Black and Red (Poom) <p>28 cm² (7cm x 4cm)</p>  |
| TROUSERS | <p>None</p> <p>* Belt is considered to belong to Dobok uniform in World Taekwondo's recognition products.</p> |

| * LOCATIONS FOR OTHER PURPOSES | | |
|--------------------------------|--|-------------|
| National Flag | At the center 3.5cm below the shoulder line of the right arm | 10cm x 7cm |
| NOC Code | The NOC code must be printed in black, using bold Verdana font, and located 5cm high or higher from the lower edge of the back of the Dobok top. | 30cm x 12cm |

DOBOK

MANUFACTURER'S IDENTIFICATION (ONE PER ITEM)

| CLOTHING | LOCATION | SIZE | LOCATION | SIZE |
|----------|---|--------------------------|----------|------|
| TOP | 3 to 3.5cm below the shoulder line of the left arm or at the right chest of the top's front (Only One MI allowed) | within 30cm ² | None | None |
| TROUSERS | At the knee of the right leg | within 30cm ² | None | None |
| Belt | At the end of the belt | within 6cm ² | None | None |

HOMOLOGATION MARK (CE)

Protector - PSS / Non-PSS

*MI – Manufacturer's Identification



| | Head Protector | Trunk Protector | Sensing Socks |
|---|--|---|---|
| Item | <p>Front</p> <p>Back</p> | | |
| WT Logo (One per item) | <p>At the point 2 to 3cm above the bottom center and left side of the back head/ kicking man with horizontal signature in white solid color on red or blue head protector</p> <p>within 6 cm²</p> | <p>At the bottom center of the front part of the trunk protector, 3cm above the size indicator/ kicking man with horizontal signature in white solid color on red or blue trunk protector</p> <p>within 14 cm²</p> | <p>At the point 1.5cm below the top center of the lower edge of the ankle fastener/ kicking man with horizontal signature in black solid color on white background color of the fastener or in white solid color on black background color of the fastener</p> <p>within 6 cm²</p> |
| MANUFACTURER'S IDENTIFICATION (ONE PER ITEM) | | | |
| MI | At the top center of the front | | |
| Location | At the center of the forehead | | |
| Size | within 8cm ² | | |
| | within 30cm ² | | |
| | within 6cm ² | | |
| HOMOLOGATION MARK (CE) | | | |
| CE | At the left side of the center of the back head, 1 to 2cm below the WT logo, white in color | | |
| Location | NONE | | |
| Size | within 4cm ² | | |
| | NONE | | |
| | NONE | | |
| Authorized Identifications | | | |
| | At the center of the front, 5cm below the WT logo | | |
| | within 6cm ² | | |

PERSONAL EQUIPMENT

*MI – Manufacturer's Identification



| | Forearm / Shin Guard | Groin Guard | Hand Protector |
|---|---|--|--|
| Item | | | |
| WT Logo (One per item) | At the bottom front of the protector/ Kicking man with horizontal signature in black solid color (on white background color of the product) | At the location available except the location for manufacturer's identification/ Kicking man with horizontal signature in black solid color (on white background color of the product) | At the center of the outer side of wrist fastener/ Kicking man with horizontal signature in black solid color on white background color of the fastener or white solid color on black background color of the fastener |
| | within 10 cm ² | within 10 cm ² | within 6 cm ² |
| | | | |
| MANUFACTURER'S IDENTIFICATION (ONE PER ITEM) | | | |
| MI | At the center of the front | | |
| Location | At the center of the front | At the center of the front | At the center of the outer part of the protectors |
| Size | within 10cm ² (Forearm) / within 14cm ² (Shin) | within 10cm ² | within 8cm ² |
| HOMOLOGATION MARK (CE) | | | |
| CE | NONE | | |
| Location | NONE | NONE | NONE |
| Size | NONE | NONE | NONE |
| Authorized Identifications | | | |

TAEKWONDO Mat (Puzzle)

*MI – Manufacturer's Identification

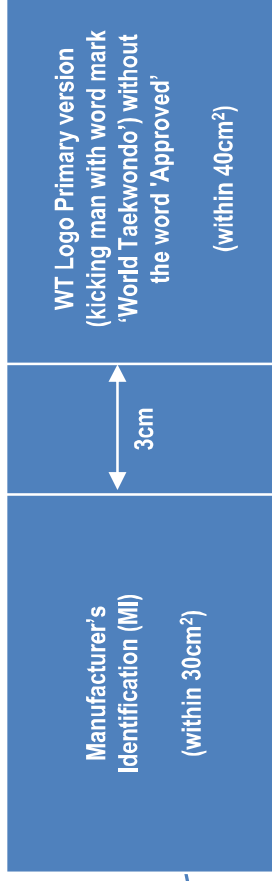
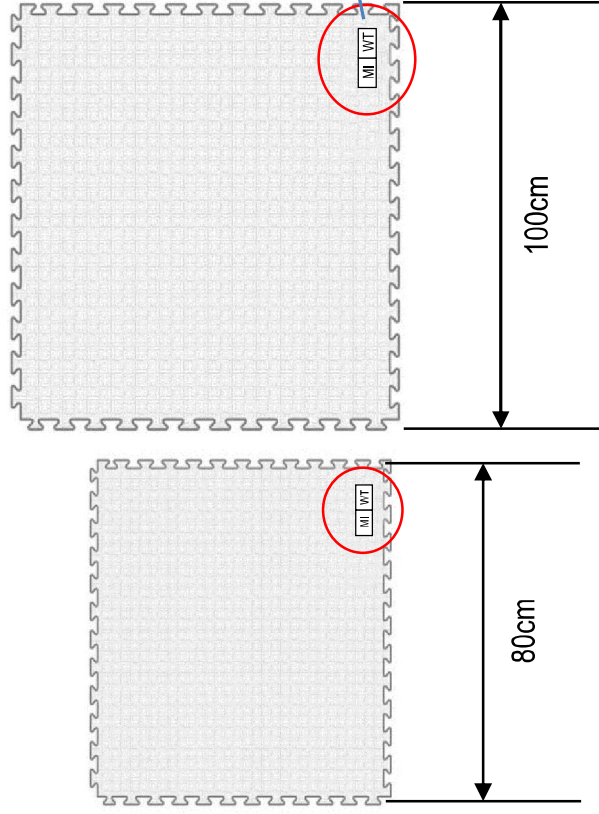

Sample



| Authorized Identifications | |
|----------------------------|--|
| Location | At one corner of the mat: 2.5cm~3cm from each end of the mat |
| Location of the two logos | MI in the left & WT logo in the right with 3cm space between the two logos |
| Size of the logos | Manufacturer's identification : within 30 cm ² / WT logo: within 40 cm ² |
| Colors of the logos | ** In case of WT logo, please be sure to put the spaces around four corners of the WT logo to keep the vertical & horizontal ratio of the form of the original WT logo |
| Colors of the logos | Colors of the logos: same as the mat color (red or blue) |
| Remark | Logos should be put in an engraved manner |

Application of WT Logo guidelines

*MI – Manufacturer's Identification



| | | |
|--|--|--|
| | | |
| | | |



75% red background, 25% contrast



75% yellow background, 25% contrast



75% blue background, 25% contrast



75% black background, 25% contrast



75% green background, 25% contrast



25% red background, 75% contrast



50% yellow background, 50% contrast

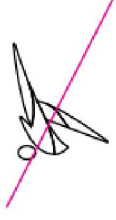

Do not change the symbol into a line.



Do not change the position of the symbol.



Do not alter the colors of the symbol.



Do not use the outlined watermark.



Do not change the position of the symbol.



Do not change the position of the symbol.



Do not alter the colors of the logo.



Do not alter the color of the watermark.

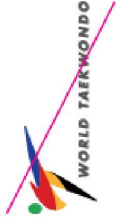

Do not change the position of the symbol.



Do not change the position of the symbol.



Do not alter the colors of the symbol.



Do not use the logo with a background that is less than 40% contrast between the logo color and the background.



Do not change the proportions of the logo.



Do not alter the direction of the symbol.



Do not alter the color of the watermark.



Do not arrange the logo on a picture.



Do not minimize the thickness of the watermark.



Do not transform the angle of the symbol.



Do not alter the colors of the symbol.



Do not arrange the logo on a complex graphic design.



Do not alter the typeface of the watermark.



Do not transform the angle of the symbol.



Do not adjust the tint of the logo.



Do not use the logo with a background that includes one of the symbol's colors.



**WORLD
TAEKWONDO**

World Taekwondo Headquarters
Booyoung Taepyeong Building 10th Floor,
55, Sejong-daero (Taepyeong-ro 2ga), Jung-gu,
Seoul, Republic of Korea, 04513

Tel : +82 2 566 2505
Fax : +82 2 553 4728

[CONTACT INFORMATION](#) [PRIVACY POLICY](#)

World Taekwondo Lausanne Office
Avenue de Rhodanie 54 1007 Lausanne
Switzerland

Email : office@worldtaekwondo.org
Tel : +41 21 601 50 13
Fax : +41 21 601 59 83